

SEZIONE
TECNICA
TECHNICAL
SECTION

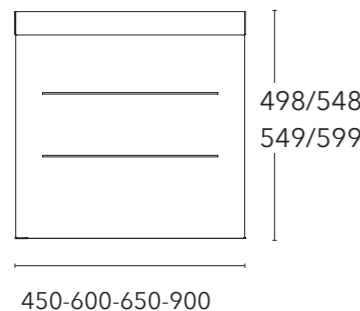

- BOISERIE MOVING WALL -



PANNELLI BOISERIE H DA 498 A 548 MM H DA 549 A 599 MM

PANNELLO L 450 MM SP. 18 MM

CODICI / CODE FINITURE / FINISHINGS			DESCRIZIONE DESCRIPTION	MISURE MEASURES	IMBALLO PACKING	VOLUME
SILVER DARK 8700P	DESERT 8700Q	GREY STONE 8700U	Pannello tra base e pensile, con regolazione automatica dell' altezza . Height adjustable panel.	H 498-548	1	0,007

CODICI / CODE FINITURE / FINISHINGS			DESCRIZIONE DESCRIPTION	MISURE MEASURES	IMBALLO PACKING	VOLUME
SILVER DARK 8701P	DESERT 8701Q	GREY STONE 8701U	Pannello tra base e pensile, con regolazione automatica dell' altezza . Height adjustable panel.	H 549-599	1	0,007

PANNELLO L 600 MM SP. 18 MM

CODICI / CODE FINITURE / FINISHINGS			DESCRIZIONE DESCRIPTION	MISURE MEASURES	IMBALLO PACKING	VOLUME
SILVER DARK 8710P	DESERT 8710Q	GREY STONE 8710U	Pannello tra base e pensile, con regolazione automatica dell' altezza . Height adjustable panel.	H 498-548	1	0,007

CODICI / CODE FINITURE / FINISHINGS			DESCRIZIONE DESCRIPTION	MISURE MEASURES	IMBALLO PACKING	VOLUME
SILVER DARK 8711P	DESERT 8711Q	GREY STONE 8711U	Pannello tra base e pensile, con regolazione automatica dell' altezza . Height adjustable panel.	H 549-599	1	0,007

PANNELLO L 650 MM SP. 18 MM

CODICI / CODE FINITURE / FINISHINGS			DESCRIZIONE DESCRIPTION	MISURE MEASURES	IMBALLO PACKING	VOLUME
SILVER DARK 8730P	DESERT 8730Q	GREY STONE 8730U	Pannello tra base e pensile, con regolazione automatica dell' altezza . Height adjustable panel.	H 498-548	1	0,008

CODICI / CODE FINITURE / FINISHINGS			DESCRIZIONE DESCRIPTION	MISURE MEASURES	IMBALLO PACKING	VOLUME
SILVER DARK 8731P	DESERT 8731Q	GREY STONE 8731U	Pannello tra base e pensile, con regolazione automatica dell' altezza . Height adjustable panel.	H 549-599	1	0,008

PANNELLO L 900 MM SP. 18 MM

CODICI / CODE FINITURE / FINISHINGS			DESCRIZIONE DESCRIPTION	MISURE MEASURES	IMBALLO PACKING	VOLUME
SILVER DARK 8720P	DESERT 8720Q	GREY STONE 8720U	Pannello tra base e pensile, con regolazione automatica dell' altezza . Height adjustable panel.	H 498-548	1	0,012

CODICI / CODE FINITURE / FINISHINGS			DESCRIZIONE DESCRIPTION	MISURE MEASURES	IMBALLO PACKING	VOLUME
SILVER DARK 8721P	DESERT 8721Q	GREY STONE 8721U	Pannello tra base e pensile, con regolazione automatica dell' altezza . Height adjustable panel.	H 549-599	1	0,012

#SONO DISPONIBILI SOLUZIONI SU RICHIESTA PER ALTRE MISURE DI INTERBASE
Other measures are available on demand

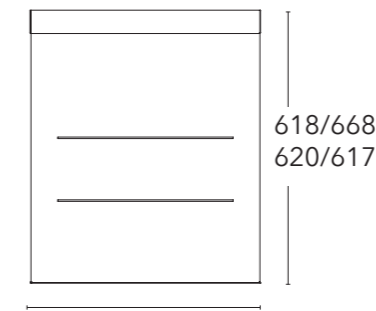

PANNELLI BOISERIE H DA 600 A 617 MM H DA 618 A 668 MM

PANNELLO L 450 MM SP. 18 MM

CODICI / CODE FINITURE / FINISHINGS			DESCRIZIONE DESCRIPTION	MISURE MEASURES	IMBALLO PACKING	VOLUME
SILVER DARK 870TP	DESERT 870TQ	GREY STONE 870TU	Pannello tra base e pensile, con regolazione automatica dell' altezza . Height adjustable panel.	H 600-617	1	0,007

CODICI / CODE FINITURE / FINISHINGS			DESCRIZIONE DESCRIPTION	MISURE MEASURES	IMBALLO PACKING	VOLUME
SILVER DARK 8703P	DESERT 8703Q	GREY STONE 8703U	Pannello tra base e pensile, con regolazione automatica dell' altezza . Height adjustable panel.	H 618-668	1	0,007

PANNELLO L 600 MM SP. 18 MM

CODICI / CODE FINITURE / FINISHINGS			DESCRIZIONE DESCRIPTION	MISURE MEASURES	IMBALLO PACKING	VOLUME
SILVER DARK 871TP	DESERT 871TQ	GREY STONE 871TU	Pannello tra base e pensile, con regolazione automatica dell' altezza . Height adjustable panel.	H 600-617	1	0,007

CODICI / CODE FINITURE / FINISHINGS			DESCRIZIONE DESCRIPTION	MISURE MEASURES	IMBALLO PACKING	VOLUME
SILVER DARK 8713P	DESERT 8713Q	GREY STONE 8713U	Pannello tra base e pensile, con regolazione automatica dell' altezza . Height adjustable panel.	H 618-668	1	0,007

PANNELLO L 650 MM SP. 18 MM

CODICI / CODE FINITURE / FINISHINGS			DESCRIZIONE DESCRIPTION	MISURE MEASURES	IMBALLO PACKING	VOLUME
SILVER DARK 873TP	DESERT 873TQ	GREY STONE 873TU	Pannello tra base e pensile, con regolazione automatica dell' altezza . Height adjustable panel.	H 600-617	1	0,008

CODICI / CODE FINITURE / FINISHINGS			DESCRIZIONE DESCRIPTION	MISURE MEASURES	IMBALLO PACKING	VOLUME
SILVER DARK 8733P	DESERT 8733Q	GREY STONE 8733U	Pannello tra base e pensile, con regolazione automatica dell' altezza . Height adjustable panel.	H 618-668	1	0,008

PANNELLO L 900 MM SP. 18 MM

CODICI / CODE FINITURE / FINISHINGS			DESCRIZIONE DESCRIPTION	MISURE MEASURES	IMBALLO PACKING	VOLUME
SILVER DARK 872TP	DESERT 872TQ	GREY STONE 872TU	Pannello tra base e pensile, con regolazione automatica dell' altezza . Height adjustable panel.	H 600-617	1	0,012

CODICI / CODE FINITURE / FINISHINGS			DESCRIZIONE DESCRIPTION	MISURE MEASURES	IMBALLO PACKING	VOLUME
SILVER DARK 8723P	DESERT 8723Q	GREY STONE 8723U	Pannello tra base e pensile, con regolazione automatica dell' altezza . Height adjustable panel.	H 618-668	1	0,012

#SONO DISPONIBILI SOLUZIONI SU RICHIESTA PER ALTRE MISURE DI INTERBASE
Other measures are available on demand

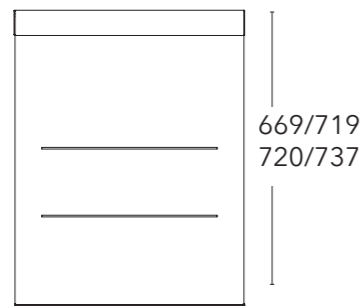

450-600-650-900

PANNELLI BOISERIE H DA 669 A 719 MM H DA 720 A 737 MM

PANNELLO L 450 MM SP. 18 MM

CODICI / CODE FINITURE / FINISHINGS			DESCRIZIONE DESCRIPTION	MISURE MEASURES	IMBALLO PACKING	VOLUME
SILVER DARK	DESERT	GREY STONE	Pannello tra base e pensile, con regolazione automatica dell' altezza . Height adjustable panel.	H 669-719	1	0,007
8704P	8704Q	8704U				

CODICI / CODE FINITURE / FINISHINGS			DESCRIZIONE DESCRIPTION	MISURE MEASURES	IMBALLO PACKING	VOLUME
SILVER DARK	DESERT	GREY STONE	Pannello tra base e pensile, con regolazione automatica dell' altezza . Height adjustable panel.	H 720-737	1	0,007
870QP	870QQ	870QU				

PANNELLO L 600 MM SP. 18 MM

CODICI / CODE FINITURE / FINISHINGS			DESCRIZIONE DESCRIPTION	MISURE MEASURES	IMBALLO PACKING	VOLUME
SILVER DARK	DESERT	GREY STONE	Pannello tra base e pensile, con regolazione automatica dell' altezza . Height adjustable panel.	H 669-719	1	0,007
8714P	8714Q	8714U				

CODICI / CODE FINITURE / FINISHINGS			DESCRIZIONE DESCRIPTION	MISURE MEASURES	IMBALLO PACKING	VOLUME
SILVER DARK	DESERT	GREY STONE	Pannello tra base e pensile, con regolazione automatica dell' altezza . Height adjustable panel.	H 720-737	1	0,007
871QP	871QQ	871QU				

PANNELLO L 650 MM SP. 18 MM

CODICI / CODE FINITURE / FINISHINGS			DESCRIZIONE DESCRIPTION	MISURE MEASURES	IMBALLO PACKING	VOLUME
SILVER DARK	DESERT	GREY STONE	Pannello tra base e pensile, con regolazione automatica dell' altezza . Height adjustable panel.	H 669-719	1	0,008
8734P	8734Q	8734U				

CODICI / CODE FINITURE / FINISHINGS			DESCRIZIONE DESCRIPTION	MISURE MEASURES	IMBALLO PACKING	VOLUME
SILVER DARK	DESERT	GREY STONE	Pannello tra base e pensile, con regolazione automatica dell' altezza . Height adjustable panel.	H 720-737	1	0,008
873QP	873QQ	873QU				

PANNELLO L 900 MM SP. 18 MM

CODICI / CODE FINITURE / FINISHINGS			DESCRIZIONE DESCRIPTION	MISURE MEASURES	IMBALLO PACKING	VOLUME
SILVER DARK	DESERT	GREY STONE	Pannello tra base e pensile, con regolazione automatica dell' altezza . Height adjustable panel.	H 669-719	1	0,012
872QP	872QQ	872QU				

CODICI / CODE FINITURE / FINISHINGS			DESCRIZIONE DESCRIPTION	MISURE MEASURES	IMBALLO PACKING	VOLUME
SILVER DARK	DESERT	GREY STONE	Pannello tra base e pensile, con regolazione automatica dell' altezza . Height adjustable panel.	H 720-737	1	0,012
872QP	872QQ	872QU				

#SONO DISPONIBILI SOLUZIONI SU RICHIESTA PER ALTRE MISURE DI INTERBASE
Other measures are available on demand

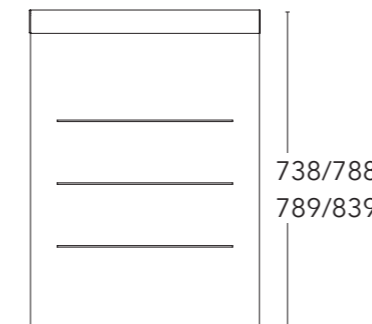

450-600-650-900

PANNELLI BOISERIE H DA 738 A 788 MM H DA 789 A 839 MM

PANNELLO L 450 MM SP. 18 MM

CODICI / CODE FINITURE / FINISHINGS			DESCRIZIONE DESCRIPTION	MISURE MEASURES	IMBALLO PACKING	VOLUME
SILVER DARK	DESERT	GREY STONE	Pannello tra base e pensile, con regolazione automatica dell' altezza . Height adjustable panel.	H 738-788	1	0,008
8705P	8705Q	8705U				

CODICI / CODE FINITURE / FINISHINGS			DESCRIZIONE DESCRIPTION	MISURE MEASURES	IMBALLO PACKING	VOLUME
SILVER DARK	DESERT	GREY STONE	Pannello tra base e pensile, con regolazione automatica dell' altezza . Height adjustable panel.	H 789-839	1	0,008
8706P	8706Q	8706U				

PANNELLO L 600 MM SP. 18 MM

CODICI / CODE FINITURE / FINISHINGS			DESCRIZIONE DESCRIPTION	MISURE MEASURES	IMBALLO PACKING	VOLUME
SILVER DARK	DESERT	GREY STONE	Pannello tra base e pensile, con regolazione automatica dell' altezza . Height adjustable panel.	H 738-788	1	0,012
8715P	8715Q	8715U				

CODICI / CODE FINITURE / FINISHINGS			DESCRIZIONE DESCRIPTION	MISURE MEASURES	IMBALLO PACKING	VOLUME
SILVER DARK	DESERT	GREY STONE	Pannello tra base e pensile, con regolazione automatica dell' altezza . Height adjustable panel.	H 789-839	1	0,012
8716P	8716Q	8716U				

PANNELLO L 650 MM SP. 18 MM

CODICI / CODE FINITURE / FINISHINGS			DESCRIZIONE DESCRIPTION	MISURE MEASURES	IMBALLO PACKING	VOLUME
SILVER DARK	DESERT	GREY STONE	Pannello tra base e pensile, con regolazione automatica dell' altezza . Height adjustable panel.	H 738-788	1	0,015
8735P	8735Q	8735U				

CODICI / CODE FINITURE / FINISHINGS			DESCRIZIONE DESCRIPTION	MISURE MEASURES	IMBALLO PACKING	VOLUME
SILVER DARK	DESERT	GREY STONE	Pannello tra base e pensile, con regolazione automatica dell' altezza . Height adjustable panel.	H 789-839	1	0,015
8736P	8736Q	8736U				

PANNELLO L 900 MM SP. 18 MM

CODICI / CODE FINITURE / FINISHINGS			DESCRIZIONE DESCRIPTION	MISURE MEASURES	IMBALLO PACKING	VOLUME
SILVER DARK	DESERT	GREY STONE	Pannello tra base e pensile, con regolazione automatica dell' altezza . Height adjustable panel.	H 738-788	1	0,017
8725P	8725Q	8725U				

CODICI / CODE FINITURE / FINISHINGS			DESCRIZIONE DESCRIPTION	MISURE MEASURES	IMBALLO PACKING	VOLUME
SILVER DARK	DESERT	GREY STONE	Pannello tra base e pensile, con regolazione automatica dell' altezza . Height adjustable panel.	H 789-839	1	0,017
8726P	8726Q	8726U				

#SONO DISPONIBILI SOLUZIONI SU RICHIESTA PER ALTRE MISURE DI INTERBASE
Other measures are available on demand

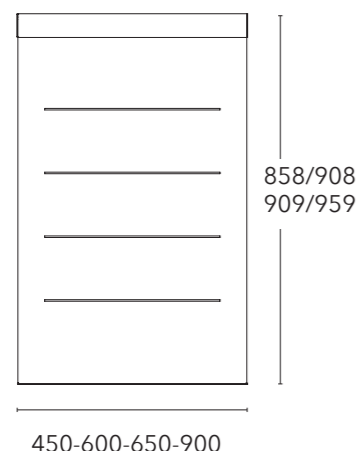

PANNELLI BOISERIE H DA 858 A 908 MM H DA 909 A 959 MM

PANNELLO L 450 MM SP. 18 MM

CODICI / CODE FINITURE / FINISHINGS			DESCRIZIONE DESCRIPTION	MISURE MEASURES	IMBALLO PACKING	VOLUME
SILVER DARK 8707P	DESERT 8707Q	GREY STONE 8707U	Pannello tra base e pensile, con regolazione automatica dell' altezza . Height adjustable panel.	H 858-908	1	0,008

CODICI / CODE FINITURE / FINISHINGS			DESCRIZIONE DESCRIPTION	MISURE MEASURES	IMBALLO PACKING	VOLUME
SILVER DARK 8708P	DESERT 8708Q	GREY STONE 8708U	Pannello tra base e pensile, con regolazione automatica dell' altezza . Height adjustable panel.	H 909-959	1	0,008

PANNELLO L 600 MM SP. 18 MM

CODICI / CODE FINITURE / FINISHINGS			DESCRIZIONE DESCRIPTION	MISURE MEASURES	IMBALLO PACKING	VOLUME
SILVER DARK 8717P	DESERT 8717Q	GREY STONE 8717U	Pannello tra base e pensile, con regolazione automatica dell' altezza . Height adjustable panel.	H 858-908	1	0,012

CODICI / CODE FINITURE / FINISHINGS			DESCRIZIONE DESCRIPTION	MISURE MEASURES	IMBALLO PACKING	VOLUME
SILVER DARK 8718P	DESERT 8718Q	GREY STONE 8718U	Pannello tra base e pensile, con regolazione automatica dell' altezza . Height adjustable panel.	H 909-959	1	0,012

PANNELLO L 650 MM SP. 18 MM

CODICI / CODE FINITURE / FINISHINGS			DESCRIZIONE DESCRIPTION	MISURE MEASURES	IMBALLO PACKING	VOLUME
SILVER DARK 8737P	DESERT 8737Q	GREY STONE 8737U	Pannello tra base e pensile, con regolazione automatica dell' altezza . Height adjustable panel.	H 858-908	1	0,015

CODICI / CODE FINITURE / FINISHINGS			DESCRIZIONE DESCRIPTION	MISURE MEASURES	IMBALLO PACKING	VOLUME
SILVER DARK 8738P	DESERT 8738Q	GREY STONE 8738U	Pannello tra base e pensile, con regolazione automatica dell' altezza . Height adjustable panel.	H 909-959	1	0,015

PANNELLO L 900 MM SP. 18 MM

CODICI / CODE FINITURE / FINISHINGS			DESCRIZIONE DESCRIPTION	MISURE MEASURES	IMBALLO PACKING	VOLUME
SILVER DARK 8727P	DESERT 8727Q	GREY STONE 8727U	Pannello tra base e pensile, con regolazione automatica dell' altezza . Height adjustable panel.	H 858-908	1	0,017

CODICI / CODE FINITURE / FINISHINGS			DESCRIZIONE DESCRIPTION	MISURE MEASURES	IMBALLO PACKING	VOLUME
SILVER DARK 8728P	DESERT 8728Q	GREY STONE 8728U	Pannello tra base e pensile, con regolazione automatica dell' altezza . Height adjustable panel.	H 909-959	1	0,017

#SONO DISPONIBILI SOLUZIONI SU RICHIESTA PER ALTRE MISURE DI INTERBASE
Other measures are available on demand

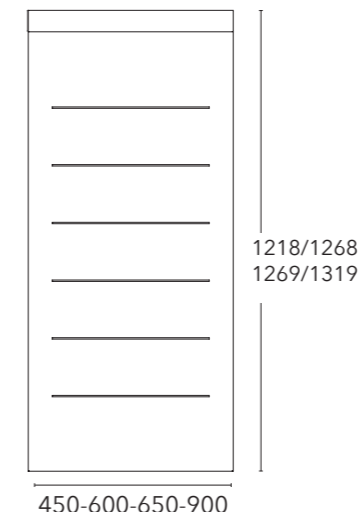

PANNELLI BOISERIE H DA 1218 A 1268 MM H DA 1269 A 1319 MM

PANNELLO L 450 MM SP. 18 MM

CODICI / CODE FINITURE / FINISHINGS			DESCRIZIONE DESCRIPTION	MISURE MEASURES	IMBALLO PACKING	VOLUME
SILVER DARK 870IP	DESERT 870IQ	GREY STONE 870IU	Pannello tra base e pensile, con regolazione automatica dell' altezza . Height adjustable panel.	H 1218-1268	1	0,012

CODICI / CODE FINITURE / FINISHINGS			DESCRIZIONE DESCRIPTION	MISURE MEASURES	IMBALLO PACKING	VOLUME
SILVER DARK 870MP	DESERT 870MQ	GREY STONE 870MU	Pannello tra base e pensile, con regolazione automatica dell' altezza . Height adjustable panel.	H 1269-1319	1	0,012

PANNELLO L 600 MM SP. 18 MM

CODICI / CODE FINITURE / FINISHINGS			DESCRIZIONE DESCRIPTION	MISURE MEASURES	IMBALLO PACKING	VOLUME
SILVER DARK 871IP	DESERT 871IQ	GREY STONE 871IU	Pannello tra base e pensile, con regolazione automatica dell' altezza . Height adjustable panel.	H 1218-1268	1	0,018

CODICI / CODE FINITURE / FINISHINGS			DESCRIZIONE DESCRIPTION	MISURE MEASURES	IMBALLO PACKING	VOLUME
SILVER DARK 871MP	DESERT 871MQ	GREY STONE 871MU	Pannello tra base e pensile, con regolazione automatica dell' altezza . Height adjustable panel.	H 1269-1319	1	0,018

PANNELLO L 650 MM SP. 18 MM

CODICI / CODE FINITURE / FINISHINGS			DESCRIZIONE DESCRIPTION	MISURE MEASURES	IMBALLO PACKING	VOLUME
SILVER DARK 873IP	DESERT 873IQ	GREY STONE 873IU	Pannello tra base e pensile, con regolazione automatica dell' altezza . Height adjustable panel.	H 1218-1268	1	0,018

CODICI / CODE FINITURE / FINISHINGS			DESCRIZIONE DESCRIPTION	MISURE MEASURES	IMBALLO PACKING	VOLUME
SILVER DARK 873MP	DESERT 873MQ	GREY STONE 873MU	Pannello tra base e pensile, con regolazione automatica dell' altezza . Height adjustable panel.	H 1269-1319	1	0,018

PANNELLO L 900 MM SP. 18 MM

CODICI / CODE FINITURE / FINISHINGS			DESCRIZIONE DESCRIPTION	MISURE MEASURES	IMBALLO PACKING	VOLUME
SILVER DARK 872IP	DESERT 872IQ	GREY STONE 872IU	Pannello tra base e pensile, con regolazione automatica dell' altezza . Height adjustable panel.	H 1218-1268	1	0,025

CODICI / CODE FINITURE / FINISHINGS			DESCRIZIONE DESCRIPTION	MISURE MEASURES	IMBALLO PACKING	VOLUME
SILVER DARK 872MP	DESERT 872MQ	GREY STONE 872MU	Pannello tra base e pensile, con regolazione automatica dell' altezza . Height adjustable panel.	H 1269-1319	1	0,025

#SONO DISPONIBILI SOLUZIONI SU RICHIESTA PER ALTRE MISURE DI INTERBASE
Other measures are available on demand

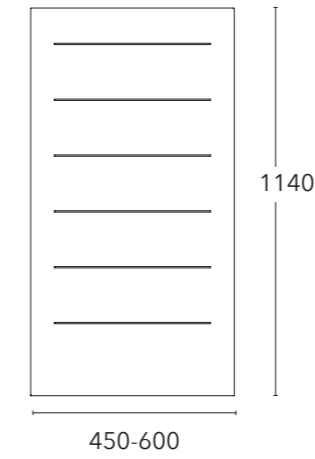

PANNELLI FISSI SOPRA TOP

PANNELLO FISSO SP. 18 MM

CODICI / CODE FINITURE / FINISHINGS			DESCRIZIONE DESCRIPTION	MISURE MEASURES	IMBALLO PACKING	VOLUME
SILVER DARK	DESERT	GREY STONE	Pannello sopratop, altezza fissa Panel fixed height	L 450 H 1140	1	0,016
8702P	8702Q	8702U				
CODICI / CODE FINITURE / FINISHINGS			DESCRIZIONE DESCRIPTION	MISURE MEASURES	IMBALLO PACKING	VOLUME
SILVER DARK	DESERT	GREY STONE	Pannello sopratop, altezza fissa Panel fixed height	L 600 H 1140	1	0,018
8712P	8712Q	8712U				



PANNELLI FISSI FINE COLONNA

PANNELLO FISSO SP. 18 MM

CODICI / CODE FINITURE / FINISHINGS			DESCRIZIONE DESCRIPTION	MISURE MEASURES	IMBALLO PACKING	VOLUME
SILVER DARK	DESERT	GREY STONE	Pannello fine colonna, altezza fissa Side pantry Panel fixed height	L 577 H 2137	1	0,017
8740P	8740Q	8740U				
CODICI / CODE FINITURE / FINISHINGS			DESCRIZIONE DESCRIPTION	MISURE MEASURES	IMBALLO PACKING	VOLUME
SILVER DARK	DESERT	GREY STONE	Pannello fine colonna, altezza fissa Side pantry Panel fixed height	L 577 H 2017	1	0,017
874PP	874PQ	874PU				



PANNELLI FISSI ISOLA/PENISOLA

PANNELLO FISSO SP. 18 MM

CODICI / CODE FINITURE / FINISHINGS			DESCRIZIONE DESCRIPTION	MISURE MEASURES	IMBALLO PACKING	VOLUME
SILVER DARK	DESERT	GREY STONE	Pannello isola/penisola altezza fissa pieg.dietro Under base panel.	L 600 H 697	1	0,011
8754P	8754Q	8754U				
CODICI / CODE FINITURE / FINISHINGS			DESCRIZIONE DESCRIPTION	MISURE MEASURES	IMBALLO PACKING	VOLUME
SILVER DARK	DESERT	GREY STONE	Pannello isola/penisola altezza fissa pieg.dietro Under base panel.	L 600 H 727	1	0,011
875DP	875DQ	875DU				
CODICI / CODE FINITURE / FINISHINGS			DESCRIZIONE DESCRIPTION	MISURE MEASURES	IMBALLO PACKING	VOLUME
SILVER DARK	DESERT	GREY STONE	Pannello isola/penisola altezza fissa pieg.dietro Under base panel.	L 600 H 817	1	0,011
8756P	8756Q	8756U				
CODICI / CODE FINITURE / FINISHINGS			DESCRIZIONE DESCRIPTION	MISURE MEASURES	IMBALLO PACKING	VOLUME
SILVER DARK	DESERT	GREY STONE	Pannello isola/penisola altezza fissa pieg.dietro Under base panel.	L 912 H 697	1	0,016
8764P	8764Q	8764U				
CODICI / CODE FINITURE / FINISHINGS			DESCRIZIONE DESCRIPTION	MISURE MEASURES	IMBALLO PACKING	VOLUME
SILVER DARK	DESERT	GREY STONE	Pannello isola/penisola altezza fissa pieg.dietro Under base panel.	L 912 H 727	1	0,016
876DP	876DQ	876DU				
CODICI / CODE FINITURE / FINISHINGS			DESCRIZIONE DESCRIPTION	MISURE MEASURES	IMBALLO PACKING	VOLUME
SILVER DARK	DESERT	GREY STONE	Pannello isola/penisola altezza fissa pieg.dietro Under base panel.	L 912 H 817	1	0,016
8766P	8766Q	8766U				

ACCESSORI ACCESSORIES

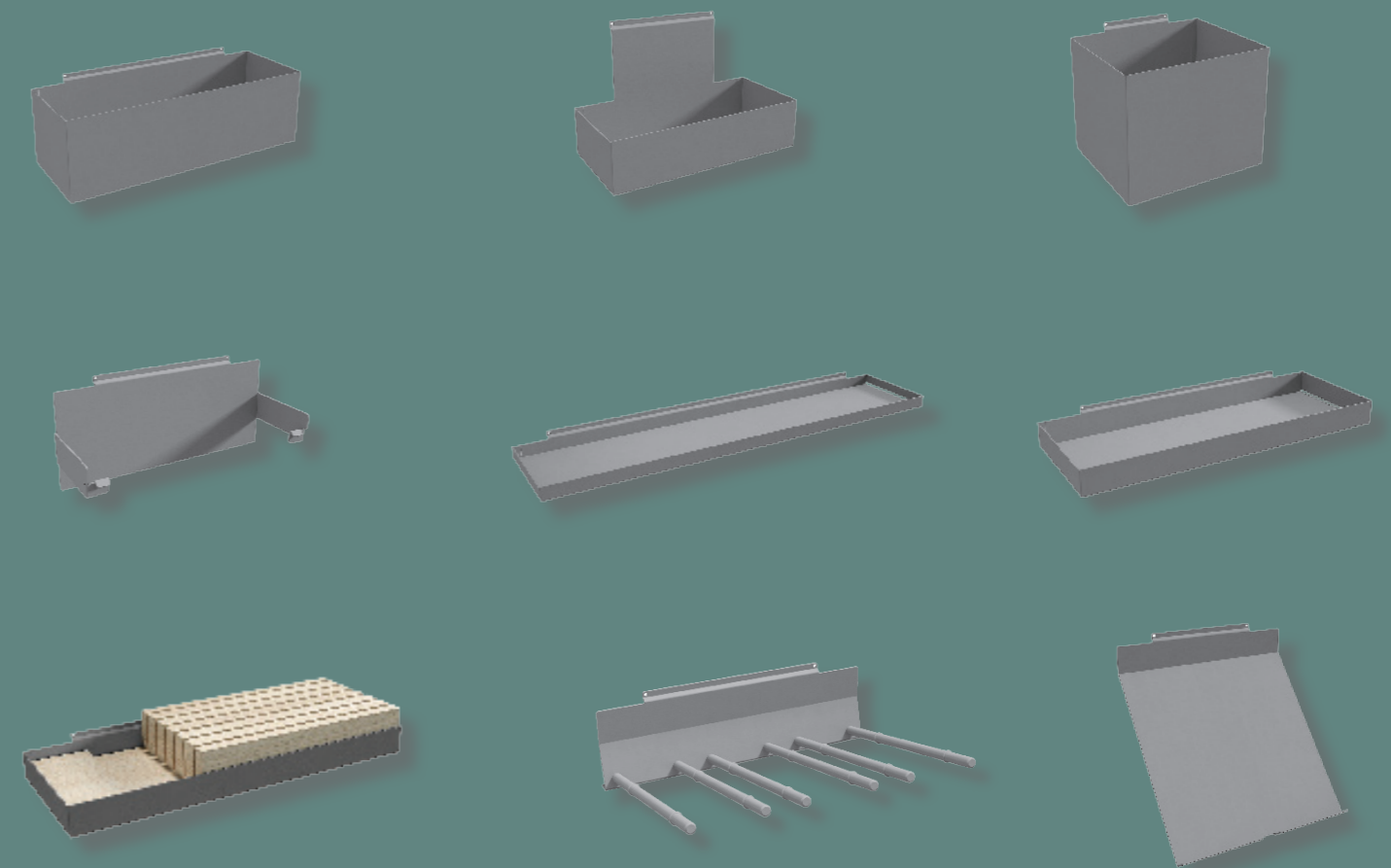

ACCESSORI ACCESSORIES

MENSOLA/Rack

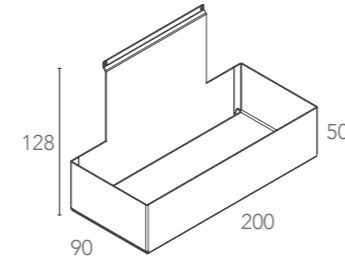

CODICI / CODE FINITURE / FINISHINGS			DESCRIZIONE DESCRIPTION	MISURE MEASURES	IMBALLO PACKING	VOLUME
SILVER DARK	DESERT	GREY STONE	Mensola "Ortaggi"/"Vegetable" Rack	L 200 P 90 H 128	1	0,006
8010P	8010Q	8010U				

MENSOLA/Rack

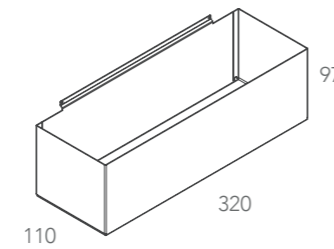

CODICI / CODE FINITURE / FINISHINGS			DESCRIZIONE DESCRIPTION	MISURE MEASURES	IMBALLO PACKING	VOLUME
SILVER DARK	DESERT	GREY STONE	Mensola "Ortaggi"/"Vegetable" Rack	L 320 P 110 H 97	1	0,005
8020P	8020Q	8020U				

MENSOLA/Rack

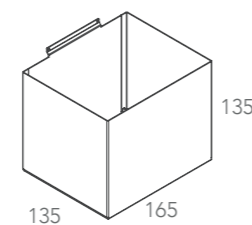

CODICI / CODE FINITURE / FINISHINGS			DESCRIZIONE DESCRIPTION	MISURE MEASURES	IMBALLO PACKING	VOLUME
SILVER DARK	DESERT	GREY STONE	Mensola "Ortaggi"/"Vegetable" Rack	L 165 P 135 H 135	1	0,004
8030P	8030Q	8030U				

ACCESSORI ACCESSORIES

RIPIANO/Shelf

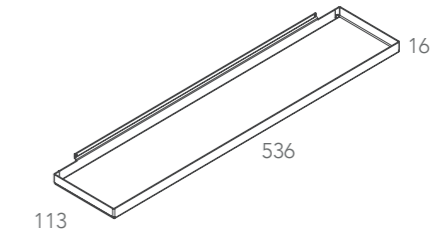

CODICI / CODE FINITURE / FINISHINGS			DESCRIZIONE DESCRIPTION	MISURE MEASURES	IMBALLO PACKING	VOLUME
SILVER DARK	DESERT	GREY STONE	Ripiano/Shelf	L 536 P 113 H 16	1	0,002
8040P	8040Q	8040U				

RIPIANO/Shelf

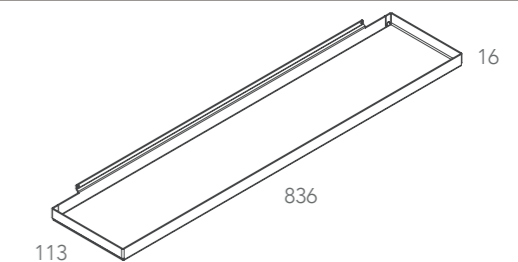

CODICI / CODE FINITURE / FINISHINGS			DESCRIZIONE DESCRIPTION	MISURE MEASURES	IMBALLO PACKING	VOLUME
SILVER DARK	DESERT	GREY STONE	Ripiano/Shelf	L 836 P 113 H 16	1	0,002
8050P	8050Q	8050U				

RIPIANO/Shelf

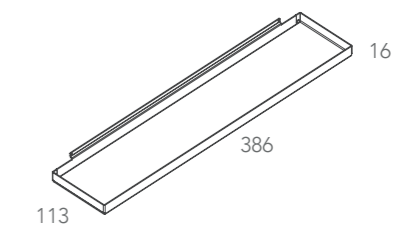

CODICI / CODE FINITURE / FINISHINGS			DESCRIZIONE DESCRIPTION	MISURE MEASURES	IMBALLO PACKING	VOLUME
SILVER DARK	DESERT	GREY STONE	Ripiano/Shelf	L 386 P 113 H 16	1	0,002
8060P	8060Q	8060U				

RIPIANO/Shelf

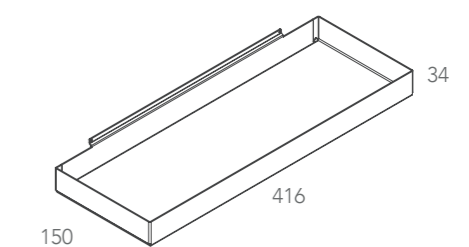

CODICI / CODE FINITURE / FINISHINGS			DESCRIZIONE DESCRIPTION	MISURE MEASURES	IMBALLO PACKING	VOLUME
SILVER DARK	DESERT	GREY STONE	Ripiano/Shelf	L 4160 P 150 H 34	1	0,002
8070P	8070Q	8070U				

ACCESSORI ACCESSORIES

MENSOLA PORTACALICI/Glassholder

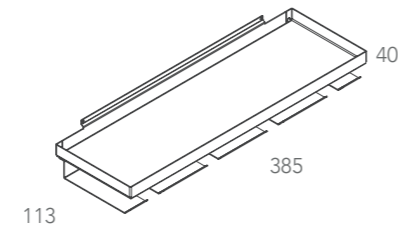

CODICI / CODE FINITURE / FINISHINGS			DESCRIZIONE DESCRIPTION	MISURE MEASURES	IMBALLO PACKING	VOLUME
SILVER DARK	DESERT	GREY STONE	MMensola Portacalici/Glassholder	L 536 P 113 H 40	1	0,008
8140P	8140Q	8140U				

MENSOLA PORTACALICI/Glassholder

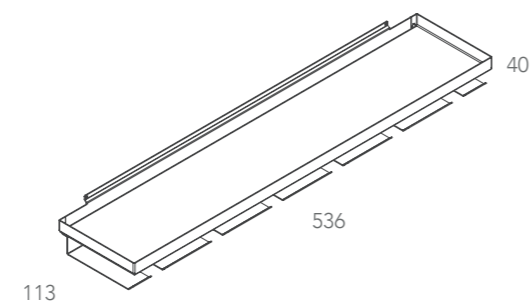

CODICI / CODE FINITURE / FINISHINGS			DESCRIZIONE DESCRIPTION	MISURE MEASURES	IMBALLO PACKING	VOLUME
SILVER DARK	DESERT	GREY STONE	MMensola Portacalici/Glassholder	L 536 P 113 H 40	1	0,008
8130P	8130Q	8130U				

PORTA BOTTIGLIE/Bottle Rack

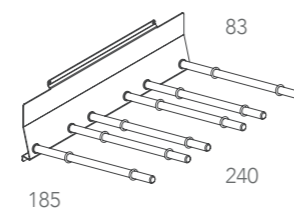

CODICI / CODE FINITURE / FINISHINGS			DESCRIZIONE DESCRIPTION	MISURE MEASURES	IMBALLO PACKING	VOLUME
SILVER DARK	DESERT	GREY STONE	Porta Bottiglie/Bottle Rack	L 240 P 185 H 83	1	0,005
8180P	8180Q	8180U				

ACCESSORI ACCESSORIES

GANCIO/Hook

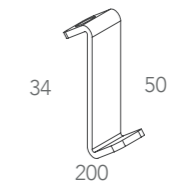

CODICI / CODE FINITURE / FINISHINGS			DESCRIZIONE DESCRIPTION	MISURE MEASURES	IMBALLO PACKING	VOLUME
SILVER DARK	DESERT	GREY STONE	Gancio/Hook	L 9 P 10 H 34	1	0,001
8400P	8400Q	8400U				

PORTA CARTA/Paper Rack

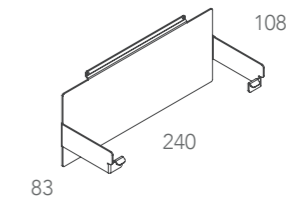

CODICI / CODE FINITURE / FINISHINGS			DESCRIZIONE DESCRIPTION	MISURE MEASURES	IMBALLO PACKING	VOLUME
SILVER DARK	DESERT	GREY STONE	Porta Carta/Paper rack	L 240 P 83 H 108	1	0,004
8300P	8300Q	8300U				

MENSOLA PORTACOLTELLI/Knife Rack

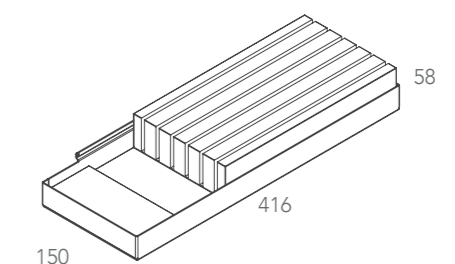

CODICI / CODE FINITURE / FINISHINGS			DESCRIZIONE DESCRIPTION	MISURE MEASURES	IMBALLO PACKING	VOLUME
SILVER DARK	DESERT	GREY STONE	Mensola PortacolteLLi/Knife Rack	L 416 P 150 H 58	1	0,004
8120P	8120Q	8120U				

ACCESSORI ACCESSORIES

PORTA TABLET/Tablet Rack

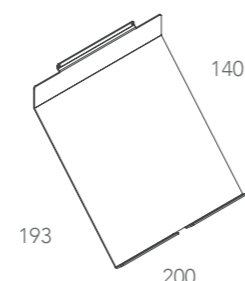

CODICI / CODE FINITURE / FINISHINGS			DESCRIZIONE DESCRIPTION	MISURE MEASURES	IMBALLO PACKING	VOLUME
SILVER DARK	DESERT	GREY STONE	Porta Tablet/Tablet Rack	L 200 P 140 H 193	1	0,002
8100P	8100Q	8100U				

PORTA RIVISTE/Magazines Rack

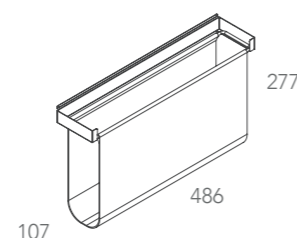

CODICI / CODE FINITURE / FINISHINGS			DESCRIZIONE DESCRIPTION	MISURE MEASURES	IMBALLO PACKING	VOLUME
SILVER DARK	DESERT	GREY STONE	Porta Riviste/Magazine Rack	L 486 P 107 H 277	1	0,006
8150P	8150Q	8150U				

PARAFIAMMA/Firewall



CODICI / CODE FINITURE / FINISHINGS			DESCRIZIONE DESCRIPTION	MISURE MEASURES	IMBALLO PACKING	VOLUME
	INOX SATINATO		Parafiamma/Firewall	L 590 P 9 H 210	1	0,005
	8160P					
CODICI / CODE FINITURE / FINISHINGS			DESCRIZIONE DESCRIPTION	MISURE MEASURES	IMBALLO PACKING	VOLUME
	INOX SATINATO		Parafiamma/Firewall	L 890 P 9 H 210	1	0,005
	8190P					

ACCESSORI ACCESSORIES

VANO A GIORNO/Open Compartment



CODICI / CODE FINITURE / FINISHINGS			DESCRIZIONE DESCRIPTION	MISURE MEASURES	IMBALLO PACKING	VOLUME
SILVER DARK	DESERT	GREY STONE	Vano a Giorno/Open Compartment	L 148 P 220 H 314	1	0,001
8200P	8200Q	8200U				

VANO A GIORNO/Open Compartment

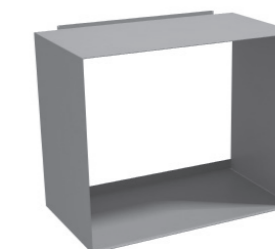

CODICI / CODE FINITURE / FINISHINGS			DESCRIZIONE DESCRIPTION	MISURE MEASURES	IMBALLO PACKING	VOLUME
SILVER DARK	DESERT	GREY STONE	Vano a Giorno/Open Compartment	L 388 P 220 H 314	1	0,004
8201P	8201Q	8201U				

VANO A GIORNO/Open Compartment

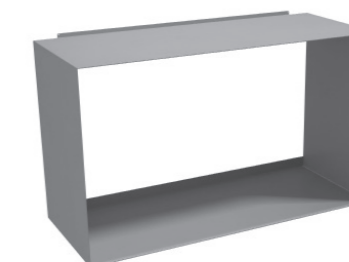

CODICI / CODE FINITURE / FINISHINGS			DESCRIZIONE DESCRIPTION	MISURE MEASURES	IMBALLO PACKING	VOLUME
SILVER DARK	DESERT	GRAY STONE	Vano a Giorno/Open Compartment	L 538 P 220 H 314	1	0,002
8202P	8202Q	8202U				